

TECHNICAL SPECIFICATION FOR REFRIGERATED CONTAINER

ISO 1AAA - 40' × 8' × 9'6"

MODEL NO: **SS4WH1 – A (R4)**

— POLYURETHANE INSULATION	
— ROOF AND SIDE PANEL	MGSS
— FRONT AND REAR END FRAME	CORTEN A/EQUIVALENT
— ALUMINUM FLOOR RAIL	
— LINING: SIDE & DOOR	STAINLESS STEEL (HGSS)
— ROOF	PRE-PAINTED ALUMINUM SHEET
— DOOR PANEL	STAINLESS STEEL (HGSS)
— TOP & BOTTOM RAIL	CORTEN A/EQUIVALENT
— CORRUGATED BASE	CORTEN A/EQUIVALENT
— REEFER UNIT POSITION	HIGH MOUNT

SPEC NO.: SS4WH1-A(R4)-FX

ISSUED DATE: March 23, 2005

REVISED DATE:

SHANGHAI REEFERCO CONTAINER CO., LTD.

1. GENERAL

- 1) The container model SS4WH1-A(R4) (ISO 1AAA) Reefer is designed for the carriage of foodstuffs frozen, chilled and general cargo by road, rail and sea (above or below decks) and is suitable for the environmental conditions imposed by these modes of transports.
- 2) The container is designed for the carriage of deep frozen, frozen and chilled (excluding hung-chilled meat) cargoes in the range -25°C to +25°C with external temperature ranging from -40°C to +70°C and is suitable to be subjected to severe thermal shock.
- 3) Refrigeration unit: Thermoking CRR40(weight: 530kg / 1170lb)

2. STANDARDS & REGULATIONS

- ISO TC - 104
 - 668 -Classification, dimensions and ratings (1995 edition)
 - 1161- Corner fittings-specification (1990 edition)
 - 1496/2 - Specification and testing (1996 edition)
 - Part 2: Thermal containers
 - 6346 - Coding, identification and marking (1995 edition)
- CSC requirements
- TIR requirements
- Timber components and certificates (No exposed timber to be used)
- UIC registration
- Type approval by classification society

3. DESIGN DATA

3.1 External dimensions

Length	12,192 mm	(0, -10)	40'
Width	2,438 mm	(0, -5)	8'
Height	2,896 mm	(0, -5)	9'6"

3.2 Internal dimensions (Nominal)

Length	11,584 mm	(0, -10)
Width	2,290 mm	(0, -8)
Height	2,552.5 mm	(0, -10)

3.3 Door openings (Nominal)

Width	2,294 mm	(0, -5)
Height — at sill	2,574 mm	(0,-5)
Cargo access height	2,510.5 mm	(0,-10)

3.4 Cubic capacity

67.7 m³ 2390 cu. ft.

3.5 Weights & ratings

Tare weight (Including Ref. Unit)	4,720 kg ±2%	(10,410 lb.)
(Excluding Ref. Unit)	4,190 kg ±2%	(9,240 lb.)
Payload	29,280 kg	(64,550 lb.)
Max. Gross Weight	34,000 kg	(74,960 lb.)

3.6 Thickness & density of thermal insulating PUR foam

	Thickness (mm)	Density (kg/m ³)
Side	63	50 - 55
Door	74	50 - 55
Roof	90	45 - 50
Floor	Min. 75 Max. 128	55 -60
Corner		45

3.7 Insulation

Polyurethane foam with R-141b (non-CFC) blowing agent:

Air leakage : $Q_{max} = 5 \text{ m}^3/\text{hr}$ (176.5cu. ft./hr) at 25.4mm WPG inside

Heat transfer rate : $U_{max} = 36 \text{ kcal/hr. } ^\circ\text{C}$ (41.9 W/K) at 20°C mean temp.

4. CONSTRUCTIONS

4.1 Base frame

- 1) Tunnel plate : 4.0mm thick one piece pressed hat section
- 2) Tunnel bolster : Welded box section with 4.0mm thick upper and 4.5mm thick lower
- 3) Load transfer member : 4.5mm thick pressed “U” section
- 4) Base panel : 1.6mm thick corrugated panel welded to the bottom side rail
- 5) Bottom side rail : 4.0mm thick upper and lower cold rolled steel

4.2 Floor

- 1) Floor board : 63.5mm high and spaced aluminum extruded “T” section
- 2) Floor bow : Aluminum extruded omega section floor bow shall be stitch welded to the under side of floor board.

4.3 Front frame

- 1) Front top rail : 4.0mm thick pressed profile
- 2) Front bottom rail : Welded construction with 4.0mm thick pressed profile.
- 3) Corner post : Welded construction with 6.0mm thick outer and inner pressed profile
- 4) Double plate : 4mm thick rectangular plates

4.4 Rear end frame

- 1) Door header : Welded construction with 4.0mm thick outer and 3.0mm thick inner, and four (4) vertical gusset plates welded behind of cam keepers
- 2) Door sill : Welded construction with 6.0mm thick outer and 4.0mm thick inner, and four (4) vertical gusset plates welded behind of cam keepers
- 3) Corner post : Welded construction with 6.0mm thick outer and inner, and with 12mm thick reinforcement plate.
- 4) Double plate : 4.0mm thick rectangular plate

4.5 Door panel

Each door is capable of swinging 270 degree when opened, which is designed to prevent left hand door from opening before right hand door in TIR requirements.

- | | |
|------------------|--|
| 1) Door panel | (1) Outer –1.6mm thick pre-painted stainless steel sheet
(2) Inner – Corten pressed section |
| 2) Door Gaskets | (1) Outer gaskets –EPDM “C” section double lips
(2) Inner gaskets – EPDM “O” section |
| 3) Locking Gears | : SAEJIN SJ-77M or eq., with anti-theft handle & secure cam
& keeper on right door center, hot-dip galvanized 75μ |
| 4) Door Hinge | : Ten (10) hot dip galvanized steel hinge with bronze bushes and stainless steel washers. |
| 5) Hinge pin | : Ø12mm stainless steel bar fixed by flaring |
| 6) Door Lining | : 0.7mm thick stainless sheet, with 12mm deep pressed battens |
| 7) Hinge lug | : 6.0mm thick MGSS plate |

4.6 Side Wall

- | | |
|-------------------|---|
| 1) Outer cladding | : 0.8mm thick main and 1.0mm thick end MGSS with vertical corrugations, welded together by TIG method |
| 2) Inner lining | : 0.7mm thick HGSS with deep inverted battens, welded together by TIG method |
| 3) Top side rail | : 4mm thick cold rolled section |
| 4) Side post | : Three(3) 4.0mm thick and four(4) 2.0mm thick pressed omega section per side, bonded to side panel by bi-adhesive structure tape or glue |
| 5) Side stringer | : Four(4) per side, MGSS pressed omega section, spot welded to side lining. |

4.7 Roof

- | | |
|-------------------|--|
| 1) Outer cladding | : 0.8mm thick main and 1.0mm thick end MGSS with deep pressed corrugations, welded together by TIG method |
| 2) Lining | : 0.9mm thick one piece pre-painted aluminum sheet, with small bead corrugations |
| 3) Roof bow | : Three(3) pieces CORTEN A pressed omega section |
| 4) Roof stringer | : Five(5) aluminum omega section, bonded to roof lining by bi-adhesive structure tape or glue and fixed with three(3) rivets |

4.8 Particular attachment

1) Tectrol system

Recesses for the tectrol track is provided at the rear end of the container, the tectrol track is not included, if requirement, we can install the tectrol track.

2) Floor drain

Two(2) drains are provided at each front and rear end. [Total four (4)]

3) Lashing bar

Six (6) pieces lashing bar per side. [Total twelve (12)]

4) Generator set mounting receptacles

Front corner post and front top rail fitted with receptacles and brackets for mounting clip-on generator set.

4.9 Marking

All containers to be marked in accordance with latest standard regulation and owner's specification.

5. SURFACE PREPARATION AND PROTECTION

5.1. Surface preparation

5.1.1. Prior to assembly

- 1) All steel components, prior to forming, will be shot blasted to Swedish Standard Sa 2.5 to remove rust, mill scale etc, and applied with zinc rich primer approx. 10 micron.
- 2) All stainless steel components, prior to forming, will be cleaned to all oil and dirt etc.
- 3) Gear cam keepers will be electro zinc plated. (Thickness : Min. 16 micron)
- 4) Locking rod assemblies are welded with gear cams, bars, holders and handle hinges are hot dip galvanized. (Thickness: Min. 75 micron)

5.1.2. After assembly

- 1) All stainless steel parts will be sweep blasted with non-metallic media and cleaned
to remove all oil rust, dirt and hot rolled mill scale and etc.
- 2) Welding seam line will be blasted to remove all welding slags, spatters and other foreign matters.

5.1.3. Polyurethane contact surfaces

Glue or adhesive primer will be applied to the polyurethane contacting surfaces for good adhesion with polyurethane.

5.2. Painting

All steel parts shall be painted as follows:

5.2.1. SPA-H parts

1) Outside surfaces (end frame & side top & bottom rail)

1st primer: ZINC RICH PRIMER	- 30 micron
2nd primer: RETAN SC UNDERCOAT	- 40 micron
3rd top: RETAN 6000 SC RAL 9010	- 40 micron

2) Polyurethane foaming contact surfaces (inside surface)

1st primer : RETAN SC UNDERCOAT	- 20 micron
---------------------------------	-------------

5.2.2. MGSS parts (roof and side panel)

1st primer: RETAN SC UNDERCOAT	- 40micron
2nd top: RETAN 6000 SC RAL 9010	- 40micron

5.2.3. Foaming contact area (HGSS, MGSS, T-floor)

Adhesive primer	- 15micron
-----------------	------------

5.2.4. Door panel

1st primer: RETAN SC UNDERCOAT	- 50micron
2nd top : RETAN 6000 SC RAL 9010	- 40micron

5.2.5. Under coating

1st primer: Zinc rich primer	- 40micron
2nd top : Bitumen/wax	- 200micron

Paint supplier: KANSAI

6. MATERIAL SPECIFICATION

1) The main materials used in construction are as follow:

<u>Where used</u>	<u>Material</u>	<u>Yield point</u> (N/mm ²) (min.)	<u>Tensile strength</u> (N/mm ²)(min.)	<u>Elongation</u> (%)
Floor Rail	Al. Alloy Extrusion AA6061-T6	225	270	8
Roof Lining	Al. Alloy Sheet AA5052-H16/H46	180	240	6
Side/roof panel	MGSS	280	420	20
Side/door lining door panel generator fitting nut	SUS304	220	510	40
Front/rear corner post front header/sill top/bottom side rail door header/sill corrugated panel	CORTEN A / equivalent	345	485	
Carbon steel pipe lock rod	STK 51	360	520	18
Carbon steel for forged (lock rod cam keeper)	JIS S25C	270	450	25
Weldable steel castings (corner castings)	SCW 480	270	450	21
Insulation tape (between steel and aluminum)	Electrolytic buffer of PE			
Foam tape	Adhesive of PVC			
Insulation material	1) Rigid polyurethane foam 2) Blowing agent: R141b			

2) Fasteners application

Material	Shear resistance (N)	Tensile resistance (N)
Aluminum blind rivet diam. 4.8mm (3/16")	4390	4490
Aluminum blind rivet diam. 6.4mm (1/4")	7540	6500
Stainless steel blind rivet diam. 4.8mm (3/16")	4500	5500

3) Sealant

Exposed parts:

- Interior surface : TEROSTAT-930
- Exterior surface : Silicon

Understructure and hidden part: Butyl

7. TESTING & INSPECTION

1. Type approval and inspection of units is carried out by classification society.
2. Every container is manufactured under effective quality control procedures to meet the specified standards and align industrial practice. After completion all container dimensions will be checked and door operation checked.

<u>Item</u>	<u>Test load</u>	
● Stacking	1.8R – T	Load: 97,200 kg/post
● Top & bottom lifting	2.0 R - T	
● Restraint	R – T	Load : 1.0R/rail
● Racking test		
● Transverse	15,240 kg	
● Longitudinal	7,620kg	
● Strength		
— End wall	0.4 P	
— Side wall	0.6 P	
— Roof	300 kg	
— Floor (ISO +33%)	7,260 kg	
● Airtightness test		
Internal pressure 25 ± 1 mm Aq.		
● Thermal test In compliance with ISO 1496/2 Part 2 – Thermal Container		
— Test mean wall temperature 20°C		
— Temperature difference between inside and outside not less than 20°C		
● Performance test of thermal appliances In compliance with ISO 1496/2		

8. GUARANTEE

8.1 Guarantees

The guarantee period will commence the date after the certification has been issued by the classification society.

8.2 Paint guarantee

The application of paint will be guaranteed against corrosion and paint failure for a period of five (5) years. The guarantee is for faults affecting more than 10% of the painted surfaces and will assure partial or total re-painting of the container.

Corrosion caused by acids, alkalis or other chemicals, damage by abrasion, impact or accident are excluded.

8.3 Decal guarantee

The decals are warranted for seven (7) years to withstand the environmental conditions as “General” mentioned for color, stability & adhesion.

8.4 Other guarantee

This will be guaranteed against fault in construction, poor workmanship and material for a period of one (1) year. Any damages caused by mis-handling, mis-securing, mis-loading, impact and any accidents relating from bad practices are excluded.



THERMO KING CORPORATION

CREATED BY	W. BENSON	REVISION	G
BASE UNIT	MAGNUM		
REV. DATE	Mar 2 nd , 2005	PAGE 1 of	22



PRODUCT SPECIFICATION

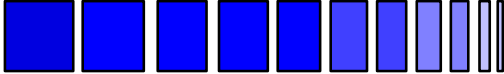

REFRIGERATION MACHINERY UNITS

MAGNUM[®]

FOR
REFRIGERATION CONTAINERS



THERMO KING CORPORATION

CREATED BY	W. BENSON	REVISION	G
BASE UNIT	MAGNUM		
REV. DATE	Mar 2 nd , 2005	PAGE 2 of	22

TABLE OF CONTENTS

GENERAL UNIT INFORMATION.....	3
DESIGN STANDARD INFORMATION.....	4
UNIT CAPACITY REFRIGERANT R404A.....	4
TEMPERATURE CONTROL.....	5
CHILLED MODE.....	5
FROZEN MODE.....	5
DEFROST.....	5
DETAIL INFORMATION ON UNIT.....	6
COMPRESSOR.....	6
EVAPORATOR COIL.....	6
CONDENSER COIL (AIR COOLED).....	6
EVAPORATOR FAN.....	6
CONDENSER FAN.....	7
EVAPORATOR FAN MOTORS.....	7
CONDENSER FAN MOTOR.....	8
DEFROST / HEATERS.....	8
ELECTRICAL SAFETY CONTROLS.....	8
CONTROL VALVES.....	8
REFRIGERATION SAFETY CONTROLS.....	9
ELECTRICAL PANEL COMPONENTS.....	9
POWER PLUG.....	9
POWER CABLE.....	9
DATALOGGER DOWNLOAD PLUG.....	9
USDA RECEPTACLE.....	9
DEHUMIDITY CONTROL.....	10
MISCELLANEOUS.....	10
MICROPROCESSOR CONTROLLER MP-3000.....	11
LCD DISPLAY.....	11
LED DISPLAY.....	11
LED DEFINITION.....	12
DATALOGGER.....	12
RETRIEVABLE DATA.....	13
FUNCTION AND PTI TEST.....	13
CONTROL ALARMS.....	14
TEMPERATURE SENSORS.....	14
GRAPHS, DRAWINGS AND DIAGRAMS.....	15
AIR FLOW MAGNUM.....	15
PIPING DIAGRAM.....	17
INSTALLATION DIAGRAMS.....	18

THERMO KING CORPORATION

CREATED BY	W. BENSON	REVISION	G
BASE UNIT	MAGNUM		
REV. DATE	Mar 2 nd , 2005	PAGE 3 of	22

GENERAL UNIT INFORMATION

Manufacturer	Thermo King Corp.
Type of System	Picture frame, electric cooling and heating single piece condenser / evaporator unit.
Construction	The refrigeration machinery is of the picture frame type. The frame is constructed of aluminum, treated to resist corrosion induced by salt spray atmosphere. The evaporator door is of the hinged removable type for easy access. The rear bulkhead panels are constructed of aluminum with a high inherent corrosion resistance. Between the evaporator and condenser section the unit is insulated with fire resistant (according to ISO 3582) and CFC-free polyurethane foam. The nominal density of the foam is 32 kg/m ³ (2 lbs/ft ³). Average thickness is 52 mm (2 inches). All aluminum material is 5000 or 6000 series.
Dimensions	Width 2 025.5 mm (79.75 in) Height 2 235.2 mm (88.00 in) Depth 420.0 mm (16.54 in) from back of the flange
Weight	422 kg (930 lbs)
Electrical System Design	Electrical system designed to comply with ISO 1496 Standard.
Designed to operate on	400 to 500 Vac 3 Ø 60 Hz ±2,5% 360 to 460 Vac 3 Ø 50 Hz ±2,5%
Control Circuit	29 Vac
Method of Heating	Electric resistance
Fresh Air Exchange Rate	Adjustable from 0 to 125 m ³ /h, 150 m ³ /h, 225 m ³ /h, 285 m ³ /h 60 Hz 0 to 104 m ³ /h, 125 m ³ /h, 187 m ³ /h, 237 m ³ /h 50 Hz
Unit Air Leakage	Less than 0.5 m ³ /h at 76 mm WG (0.29 cfm at 3.0 in WG)
Unit Heat Leakage	Less than 3.4 kCal/h/°C (3.95 W/°C)
Paint Color (Powder or Liquid)	Off-white RAL 9016/85 (Unit) / Black (Tubing/Receiver Tank)
Aluminum Corrosion Protection (Unit White 'Powder' Paint)	The unit is pre-treated then painted with Infralit Polyester powder according to ISO test 7253 and 2409 classification 1. A Polyester Powder topcoat is then applied to a film thickness of 100 µ meters.
Refrigerant	R404A – 4.0 kg (8.8 lb)

The equipment is designed to withstand and operate satisfactorily under sea-going and environmental conditions as follows:	
Ocean Environment	Salt-laden air, sea spray, high humidity and severe atmospheric conditions.
Rolling	Amplitude of 30° on each side, periods of 13 seconds
Pitching	Amplitude of 6° periods of 8 seconds
Permanent List	10° on each side
Shock	Acceleration of 2g in all directions
Vibrations	Of the types encountered on ships, land vehicles and rails

THERMO KING CORPORATION

CREATED BY	W. BENSON	REVISION	G
BASE UNIT	MAGNUM		
REV. DATE	Mar 2 nd , 2005	PAGE 4 of	22

DESIGN STANDARD INFORMATION

The machinery is designed for long distance transportation of deep frozen, frozen, chilled, or heated cargoes in a temperature range of -35°C (-31°F) to 30°C (86°F).
The machinery will be fully functional and work satisfactorily, in ambient temperatures from -30°C (-22 F) to 50°C (122°F). Components are specified to withstand temperatures up to 70°C (158°F).
The noise level of units fitted into the container will not exceed 80dB in 250 Hz band. Measurement taken in front of the unit 1.5 m (59 inch) distance and 1.2 m (47.3 inch) above ground with the unit operating at 50 Hz.
ARI - test method for rating refrigerated equipment.
Machinery complies with International Customs Regulations for Containers.
Machinery complies with relevant ISO recommendations.
Machinery complies with rules of B.V., ABS, and Lloyds.
Unit air leakage complies with Controlled Atmosphere requirements.
Refrigeration machinery complies with the requirements of the ATP regulations.
Unit complies with Australia and New Zealand Health Requirements.
Unit control system is prepared for power management (according to customer's requirements).
Unit complies with ATO (former Springer Institute) requirement regarding airflow.

UNIT CAPACITY REFRIGERANT R404a

Test method according to ARI standard no. 1110-69 approval			
Unit mounted in test room			
Net cooling capacity at 37.8°C (100°F) ambient temperature at 60 Hz power			
Evaporator Return Air Temperature	Watts	KCal/hr	BTU/hr
21°C (70°F)	15 822	13 608	54 000
2°C (35°F)	12 309	10 584	42 000
-18°C (0°F)	7 327	6 300	25 000
-29°C (-20°F)	5 070	4 360	17 300
-35°C (-31°F)	4 099	3 528	14 000
Net heating capacity (including fan heat) at 60 Hz power			
System heating capacity	5 800	4 984	19 800

THERMO KING CORPORATION

CREATED BY	W. BENSON	REVISION	G
BASE UNIT	MAGNUM		
REV. DATE	Mar 2 nd , 2005	PAGE 5 of	22

TEMPERATURE CONTROL

CHILLED MODE

If the unit is started at a set temperature of -9.9°C (14.2°F) or above, the control will be from the supply air sensor. After approximately 40 seconds the evaporator fans will start running high speed and 10 seconds later the cooling or heating sequence will be initiated. Depending on the temperature difference between setpoint and supply air sensor, the program will initiate the compressor or the heater elements according to the temperature requirements.

The cooling capacity is managed by means of PID modulated valve control. Pulsing the heaters in cycles of 30 seconds controls the heating capacity.

FROZEN MODE

With the temperature setpoint at -10°C (14°F) or below the unit will function from the return air sensor. If the return air temperature decrease 1°C (1.8°F) below setpoint, the compressor stops until the temperature has risen to 1°C (1.8°F) above setpoint. The evaporator fans run continuously in low speed except during defrost. ON - OFF cycling of the compressor is minimum 6 minutes on and minimum 6 minutes off. Both, heating and modulation control are locked in frozen mode.

DEFROST

Demand

The defrost initiation is controlled by the defrost sensor, located in the evaporator coil. This sensor will activate the demand cycle when the temperature difference between return air sensor and defrost sensor increases to a pre-set value. A probe status entry is made in the event log to note a demand cycle vs. a timed cycle.

For additional security, defrost will also be initiated on a timed basis.

Timed

Chilled mode

When starting the unit with supply air temperature at 5°C (41°F) or below, the initial defrost timer interval is two hours and increases by 30 minutes up to 6-hour intervals on time activated defrosts.

When starting the unit with supply air temperature at 5.1°C (41.2°F) or above, the defrost timer interval is eight hours.

Frozen mode

When starting the unit in frozen mode (below -10°C / 14°F), the initial defrost timer interval will be eight *compressor* hours and increases by two hours up to a twenty-four hour interval on time activated defrosts.

If the unit has been switched off for more than twelve hours or if the setpoint has been changed more than 5°C (9°F), the timer will be reset. If not, the unit will start with the same defrost sequence set by the above rules.

Termination

The defrost sensor terminates the defrost cycle automatically when the temperature in the evaporator coil rises to:

- 30 C or higher than 18°C (64.4°F) for 35 minutes in chilled mode
- 30 C or higher than 8°C (46.4°F) in 35 minutes in frozen mode

THERMO KING CORPORATION

CREATED BY	W. BENSON	REVISION	G
BASE UNIT	MAGNUM		
REV. DATE	Mar 2 nd , 2005	PAGE 6 of	22

DETAIL INFORMATION ON UNIT

<i>COMPRESSOR</i>			
Manufacturer	Copeland	Type	ZMD18KVE-TFD-277
Protection	Internal thermal automatic reset	Nominal HP	6
Locked Rotor Current	70 A @460 V / 60 Hz	Finish	Pre-treatment: Grit blast, NACE No. 1/SSPC-SP5 Finish: Listed in application order: 1. Thermally sprayed aluminum, minimum thickness of 254 µm (0.010 in) 2. Sealer per MIL STD TT-P-28, dry film thickness of 15.2 – 25.4 µm (0.0006 – 0.001 in)
Displacement	20.6 m ³ /h (726 cfm) @ 60 Hz	Weight	43 kg / 95 lb

<i>EVAPORATOR COIL</i>			
Tube Material	Copper	Fin Material	Special Aluminum DIN 1712/A199
Fin Space	3.17 mm	Configuration	Horizontal
Pipe Copper	According to DIN 1787 wall thickness 0.45 mm	Protection	Fin material pre-coated with hydrophilic coating. Coating also provides additional corrosion protection.
Surface Area	54.6 m ² (588 ft ²)	Circuits	16

<i>CONDENSER COIL (AIR COOLED)</i>			
Tube Material	Copper	Fin Material	Copper
Fin Space	2.00 mm	Configuration	Circular
Pipe Copper	According to DIN 1787 wall thickness 0.45 mm	Protection	Epoxy E-Coat with Polyurethane top coat for UV protection
Surface Area	33.4 m ² (360 ft ²)		

<i>EVAPORATOR FAN</i>			
Type	Propeller	Diameter	355 mm (14 in)
Number of Fans	2	High Speed	3 450 rpm at 60 Hz
Blade Material	Glass reinforced polypropylene	Low Speed	1 725 rpm at 60 Hz
Hubs Material	Glass reinforced polypropylene with stainless steel ring	Drive	Direct on motor shaft
Air Flows	see graph	Number of Blades	8
		Pitch	25°

THERMO KING CORPORATION

CREATED BY	W. BENSON	REVISION	G
BASE UNIT	MAGNUM		
REV. DATE	Mar 2 nd , 2005	PAGE 7 of	22

CONDENSER FAN

Type	Propeller	Diameter	550 mm (22 in)
Number of Fans	1	Speed	1 750 rpm at 60 Hz
Blade Material	Glass reinforced polyamide	Drive	Direct on motor shaft
Air Flow	6 000 m ³ /h 3 531 CFM	Number of Blades	8
Hubs Material	Glass reinforced PBT, and stainless steel ring	Pitch	30°

EVAPORATOR FAN MOTORS

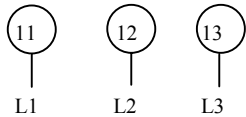
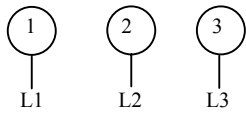
Nominal KW	0.75 kW 1.0 – 0.25 hp (60 Hz) 0.83 – 0.20 hp (50 Hz) 3 Phase	Type	Completely enclosed with separate windings for high speed, low speed, and non-ventilated
Speed	3 450 - 1 725 rpm (60Hz) 2 875 - 1 440 rpm (50Hz)	Protection	Internal thermal automatic reset (each winding)
Shaft Material	303 Stainless steel	Bearing	Ball – double sealed full contact seals (Grease - Mobil 28)
Finish	Iron phosphate pre-treatment, cathodic epoxy e-coat prime coat, black epoxy top coat	Lead Connections	High Speed  Low Speed 
No. of Motors	2	IP	56

THERMO KING CORPORATION

CREATED BY	W. BENSON	REVISION	G
BASE UNIT	MAGNUM		
REV. DATE	Mar 2 nd , 2005	PAGE 8 of	22

CONDENSER FAN MOTOR

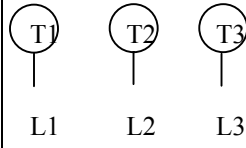
Nominal kW	0.55 kW 0.75 hp (60 Hz) 0.63 hp (50 Hz)	Type	Completely enclosed non-ventilated
Speed	1 725 rpm (60 Hz) 1 425 rpm (50 Hz)	Bearing	Ball – double sealed full contact seals (Grease – Mobil 28)
Shaft Material	303 Stainless steel	Protection	Internal thermal auto. reset
No. of Motors	1	IP	56
Finish	Iron phosphate pre-treatment, cathodic epoxy e-coat prime coat, black epoxy top coat	Lead Connections	

DEFROST / HEATERS

Defrost drain pan with high edges, 2 drains and plastic hose. Drain complies with TIR requirements. Drains are located in close proximity to condenser coil and compressor to prevent icing in cold ambient.

Defrost Heater	680 W each @ 460 V/60 Hz	No. of Defrost Heaters	6
-----------------------	--------------------------	-------------------------------	---

ELECTRICAL SAFETY CONTROLS

Overheat Klixon	Cut-out: 54°C (130°F) Cut-in: 32°C (90°F)	Compressor Motor Condenser Motor Evaporator Motor	Internal thermal automatic reset
Main Circuit Breaker	25 A		

CONTROL VALVES

Valve	Voltage	Normal Position	Function
Digital Control Valve	24 Vac	Closed	Controls the compressor loading
Economizer Valve	24 Vac	Closed	Turns the economizer cycle on and off

THERMO KING CORPORATION

CREATED BY	W. BENSON	REVISION	G
BASE UNIT	MAGNUM		
REV. DATE	Mar 2 nd , 2005	PAGE 9 of	22

REFRIGERATION SAFETY CONTROLS

Low Pressure Switch	Cut-out: -.2 to -.4 bar (5" to 11" hg) Cut-in: .3 to .5 bar (4 to 7 psig)	Fusible Plug (Receiver)	Relief Temperature 100°C (212°F)
High Pressure Switch	Cut-out: 32.4 bar (470 psig ±7 psig) Cut-in: 30.1 bar (375 psig ±38 psig)		

ELECTRICAL PANEL COMPONENTS

Contactors	Compressor CI25	Main Circuit Breaker	25A
Relays	Condenser Fan, Heater, Evaporator Fan (2 pcs.) and Phase Selection (2 pcs.)	Fuse	3 x 20 A on Main Relay Board 2 x 2 A on MP3000 1 x 7.5 A on control circuit
Transformer	Primary 500 Vac Secondary 29/28/40 Vac	Phase Sensor	Automatic selection
Switch	Unit "ON / OFF"	Battery Backup	12 Volt service free 1.9 A Capacity

POWER PLUG

Type CEE 17 (ISO 1496-2, Annex 0 0,1)	4 pole 400 / 460 Volt 50/60 Hz	Amps	32	Earth	3h pos.
--	-----------------------------------	-------------	----	-------	---------

POWER CABLE

Storage for power cable provided in condenser section

Length	18.3 m (60 ft)	Cable	4 x 4 mm ² , 450/750 V QWPK (11ga/4 conductor)
Temperature Range	-37° C (-35° F) to 90° C (194°F)	Color	Yellow

DATALOGGER DOWNLOAD PLUG

Location	One on the electrical box and one on back side of container unit.	Type	Deutsch HD10-5-16-P
-----------------	---	-------------	---------------------

USDA RECEPTACLE

Receptacle type 3 pole	Deutsch HD10-3 96 (Male)	Quantity	4 pcs.
Sensor connection type	NTC	Location	Rear left side

THERMO KING CORPORATION

CREATED BY	W. BENSON	REVISION	G
BASE UNIT	MAGNUM		
REV. DATE	Mar 2 nd , 2005	PAGE 10 of	22

DEHUMIDITY CONTROL

Humidity reduction is accomplished by re-heating the evaporator air with the defrost heaters. A control algorithm allows humidity setpoints between 60 and 100%. Condensate is drained to the outside via the defrost drain tubing.

Option includes; humidity sensor installed in return air and all required wiring and control software.

HUMIDITY SENSOR

Operational Range	60% - 90% rH	Accuracy	at 60% to 75%: $\pm 1.5\%$ at 75% to 90%: $\pm 3.0\%$
Output Signal	4 mA - 20 mA	Output per 1% rH	0.20 mA

MISCELLANEOUS

Auto PTI Includes function tests and fault diagnostics
Dual speed, double winding evaporator motors
One piece hinged and removable evaporator access door with quick release stainless steel latches
Solid State Microprocessor Controller with Backlit LCD digital display, 28 mm (1.1 inch)
Sequential component start to minimize peak amp draw
Unique fresh air change system integral ducting for wall to wall air distribution
Safety harness hooks and grab-handle
Large diameter, low speed condenser fan for quiet operation
Power saving "on demand" automatic defrost system
Tin-plated and numbered wires according to UL1647
Lightweight composite condenser and evaporator fans.
Manual operated control by-pass mode
Economy mode can be selected in both chilled and frozen range
Suction and Discharge Service Valves
Refrigerant service connections per SAE J639 (R134a automotive type) located on suction and discharge side of the compressor

CREATED BY	W. BENSON	REVISION	G
BASE UNIT	MAGNUM		
REV. DATE	Mar 2 nd , 2005	PAGE 11 of	22

MICROPROCESSOR CONTROLLER MP-3000

The MP-3000 is an advanced microprocessor temperature controller based on the latest computer technology and is developed especially for reefer control and monitoring. The controller is designed with an integrated datalogger with a link to an optional power line communications module.

Frequently used functions such as Temperature Setpoint and Defrost have been given separate hot keys for ease of operation.

Vital data are/can be shown on an LED-display with 20.32 mm high characters, ensuring easy viewing even from a long distance. The controller is equipped with the following parts:

- 1 4 line by 20 character LCD display
- 1 5 segment LED display
- 8 LED's
- 1 16 key general-purpose keyboard plus 4 hot keys

The control system consists of the following:

MP-3000 Microprocessor Controller w/ Integrated Data logger
Main Relay Board (PCB)
Temperature Sensors (7)

With exception of the sensors, all components are mounted in the control box. The design of the microprocessor provides permanent accuracy, reliability, and expandability.

In the case of a control sensor failure, another sensor will take over and automatically compensate for the difference between supply and return air temperatures.

A permanently stored base program is built into the controller and a non-volatile memory for additions or changes in software is present.

Both heating and modulation modes are locked out in frozen mode (Setpoints of -10° C or less).

Overall accuracy is $\pm 0.25^\circ\text{C}$ ($\pm 0.4^\circ\text{F}$) and verification of temperatures should be done using an instrument with equal or better performance.

LCD DISPLAY

The LCD display is used for all purposes of the operator / unit interface showing menu information, data fields, etc.

LED DISPLAY

The main purpose of the LED display is to show the sensor currently used in the control algorithm. This temperature will either be return or supply. The LED displays the controlling sensor. If a temperature is out of range the display will show "Err". A +/- sign will indicate if the out of range value is positive or negative. The first 10 seconds after power up, the LED display will show the current setpoint. The setpoint will also be shown for 5 seconds in the LED display after a new setpoint has been accepted.

Additionally, the LED display is used during PTI to show the current stage of the PTI.

THERMO KING CORPORATION

CREATED BY	W. BENSON	REVISION	G
BASE UNIT	MAGNUM		
REV. DATE	Mar 2 nd , 2005	PAGE 12 of	22

LED DEFINITION

The use of the LED's is defined as follows: (reading right to left)

- 1 Red FLASHING if error
- 2 Green ON if temperature is in range
- 3 Yellow ON if defrost is active
- 4 Yellow ON if heaters are activated
- 5 Yellow ON if compressor is running
- 6 Yellow ON if humidity control is selected
- 7 Yellow ON if supply air temperature is displayed
- 8 Yellow ON if return air temperature is displayed

If LED 7 and LED 8 (return and supply) are ON at the same time, the Setpoint is shown in the LED display. The Setpoint can be set from -35° C (-31° F) to 30° C (86° F).

At Setpoints below -10° C (14° F) the controlling sensor is return air. Heat and capacity reduction will be locked out and evaporator fan motors will be operating on low speed.

At Setpoints above -9.9° C (14.2° F), the controlling sensor is supply air. The evaporator fan motors will be operating on high speed.

DATALOGGER

The integrated datalogger is a microprocessor-based recorder specifically developed for refrigerated containers. The datalogger contains a memory area for storing temperatures.

All registrations are stored in the flash memory, which contains temperatures logged at user selectable intervals of ½, 1, 2 or 4 hours. The sensors logged are: supply air, return air, USDA, ambient and the Setpoint. Using a one-hour logging interval, temperature information covering the last 625 days is available. The logging of the USDA sensors are fixed at a one-hour interval automatically to comply with the USDA regulations.

One-minute log is only for calibration of USDA sensors. Maximum 72 minutes, self-terminating.

All logs are stored at time and date of occurrence. The Real Time Clock in the controller is set at UTC time at the factory and is backed up by a built-in extended life Lithium battery. The datalogger is equipped with high-speed serial communications port. The logs can be inspected on the LCD display of the controller.

Retrieving the datalogger can either be done by use of York Controls Logman handheld data retriever equipment, Thermo King Smart Sponge or via the REFCON / GRASP power line remote monitoring system. Retrieving by the REFCON / GRASP system requires that the controllers are equipped with ISO standard 10 368 high data rate, wide band, and power cable communication modems.

The datalogger will continue to log, 120 entries (at 1 hour interval) after the container has been turned OFF or disconnected from mains power source.

Ambient Temperature	-25° C to +70° C	Humidity	95% rh non-condensing
Temperature Accuracy	±0.15 °C	Capacity	15 000 Logs equal to 625 days continuous logging of all sensors

THERMO KING CORPORATION

CREATED BY	W. BENSON	REVISION	G
BASE UNIT	MAGNUM		
REV. DATE	Mar 2 nd , 2005	PAGE 13 of	22

RETRIEVABLE DATA

The controller contains three memory areas for data: 1. Events / Alarms, 2. Auto PTI, 3. Comments

1. Event and Alarms:

This record contains the last 1 024 events, such as information on alarms, power on/off, defrost start/end, etc.

2. Auto PTI

Records of the last two Auto PTI's performed.

3. Comments:

Entering using the keyboard on the controller, sending by the Logman handheld data retriever, or by the Thermo King Smart Sponge, comments can be entered to the controller memory.

All logs are stored at time and date of occurrence. The Real Time Clock in the controller is set at UTC time at the factory and is backed up by a built-in extended life Lithium battery. The datalogger is equipped with high-speed serial communications port. The logs can be inspected on the LCD display of the controller.

Retrieving the datalogger can either be done by use of York Controls Logman handheld data retriever equipment, Thermo King Smart Sponge or via the REFCON / GRASP power line remote monitoring system. Retrieving by the REFCON / GRASP system requires that the controllers are equipped with ISO standard 10 368 high data rate, wide band, and power cable communication modems.

FUNCTION AND PTI TEST

There are three test modes programmed in the microprocessor.

Test Mode 1

Function test. Automatically tests individual components including the controller display, sensors, condenser fan, evaporator fans and compressor. The test includes measurement of component power consumption and compares results to expected values.

Test Mode 2

Auto PTI. Automatically checks unit refrigeration capacity, heating capacity, temperature control, and individual components including controller display, contactors, fans, protection devices and sensors. The test includes measurement of component power consumption and compares results to expected values. This test mode generates a PTI log file.

Test Mode 3

Manual Function test. Allows a technician to perform specific diagnostic tests on individual components or turn several components ON at the same time to perform a system test.

THERMO KING CORPORATION

CREATED BY	W. BENSON	REVISION	G
BASE UNIT	MAGNUM		
REV. DATE	Mar 2 nd , 2005	PAGE 14 of	22

CONTROL ALARMS

Three types of alarms may occur.

1. Shutdown Alarm (Level 1): The alarm LED flashes and the unit stops. A shutdown alarm indicates that the unit has stopped to prevent damage to the unit or cargo. The condition must be corrected before the unit will restart.
2. Check Alarm (Level 2): The alarm LED flashes until the alarm is acknowledged but the unit continues to operate. A check alarm indicates corrective action should be taken.
3. Log Alarm (Level 3): The alarm is recorded in the data logger only; the alarm LED does not flash.

Sensor Alarms:

- If any sensor is defective (evaporator coil, return air, supply air, condenser coil, ambient air, or compressor discharge temperature).
- If the temperature difference between the evaporator coil, return air, or supply air sensors get either too high or too low in accordance with actual conditions.
- If the temperature difference between the two-supply air sensors is too high.

Temperature Alarm Chilling:

If temperature is not in range of $\pm 1.5^{\circ}\text{C}$ ($\pm 2.7^{\circ}\text{F}$) of the Setpoint within one hour of running, at settings of -9.9°C (14.2°F) or higher. This in-range temperature tolerance is user selectable. The alarm is ignored if the temperature is falling / rising towards the Setpoint greater than 0.1°C (0.2°F) per hour when the temperature is within 5°C (9°F) of the Setpoint. This applies to both cooling and heating.

Temperature Alarm Freezing:

If temperature is not in range of $\pm 1.5^{\circ}\text{C}$ ($\pm 2.7^{\circ}\text{F}$) of the Setpoint within one hour of running, at settings of -10°C (14°F) or below. This in-range temperature tolerance is user selectable. The alarm is ignored if the temperature is falling / rising towards the Setpoint greater than 0.1°C (0.2°F) per hour when the temperature is within 5°C (9°F) of the Setpoint.

Defrost Alarm:

If defrost interval lasts more than 90 minutes or if return air temperature is $> 38^{\circ}\text{C}$ (100°F) at 60Hz operation or 120 minutes at 50 Hz operation.

Compressor Discharge Temperature: $> 130^{\circ}\text{C}$ (266°F).

Phase Sensing: If after 20 seconds, the controller is not able to decide the correct phase direction.

Pressure: If the discharge or suction pressure exceeds programmed limits.

Power: If the voltage, frequency, or total unit current exceeds programmed limits.

TEMPERATURE SENSORS

The sensors (7) are of a thermistor design. They are linked to the controller via a two-conductor cable.

1. Evaporator Coil - Located in the center of the evaporator coil
2. Return Air - Located in the return air section
3. Supply Air 1 - Located in the supply air section
4. Supply Air 2 - Located in the supply air section
5. Condenser Coil - Located in the condenser coil
6. Ambient Air - Located on the unit front wall
7. Compressor - Located in the compressor head

CREATED BY	W. BENSON	REVISION	G
BASE UNIT	MAGNUM		
REV. DATE	Mar 2 nd , 2005	PAGE 15 of	22

GRAPHS, DRAWINGS AND DIAGRAMS

AIR FLOW MAGNUM

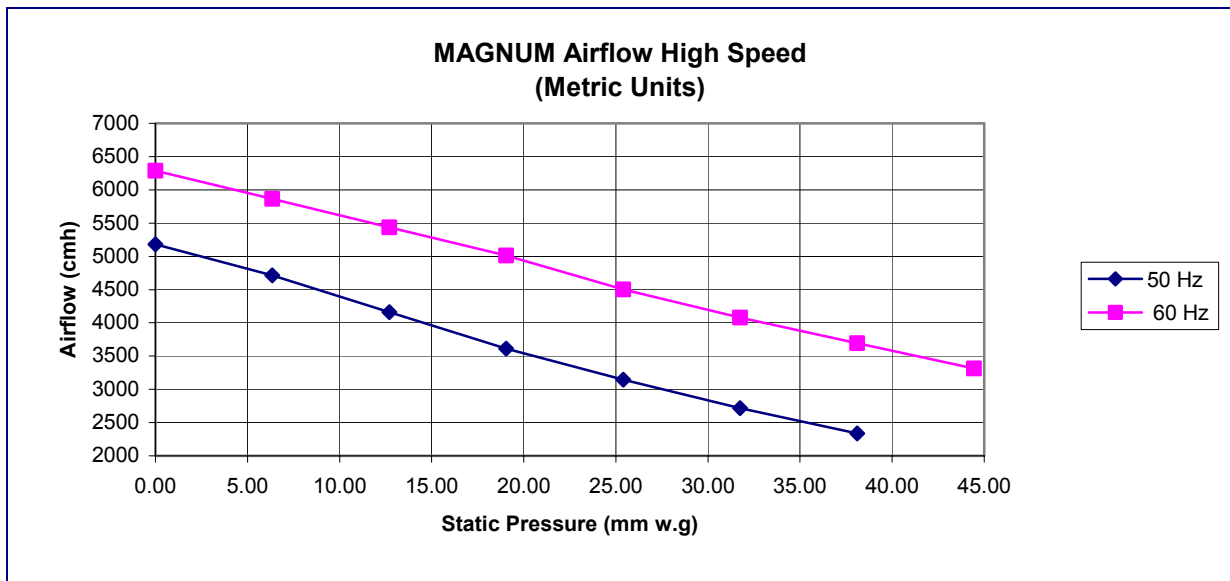
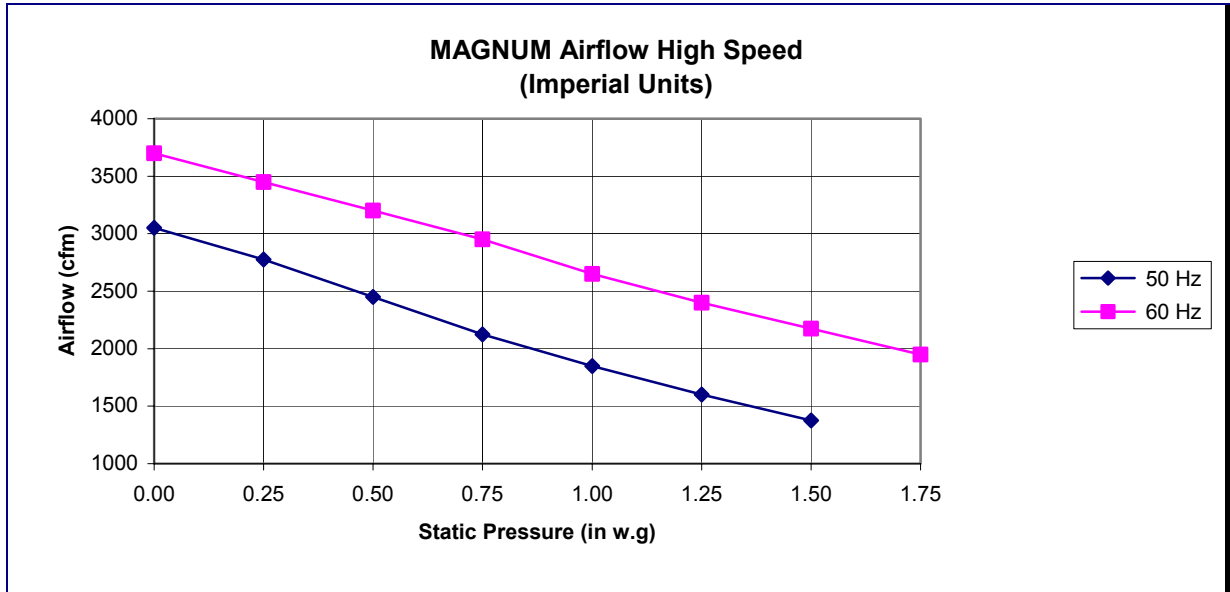

THERMO KING CORPORATION

CREATED BY	W. BENSON	REVISION	G
BASE UNIT	MAGNUM		
REV. DATE	Mar 2 nd , 2005	PAGE 16 of	22

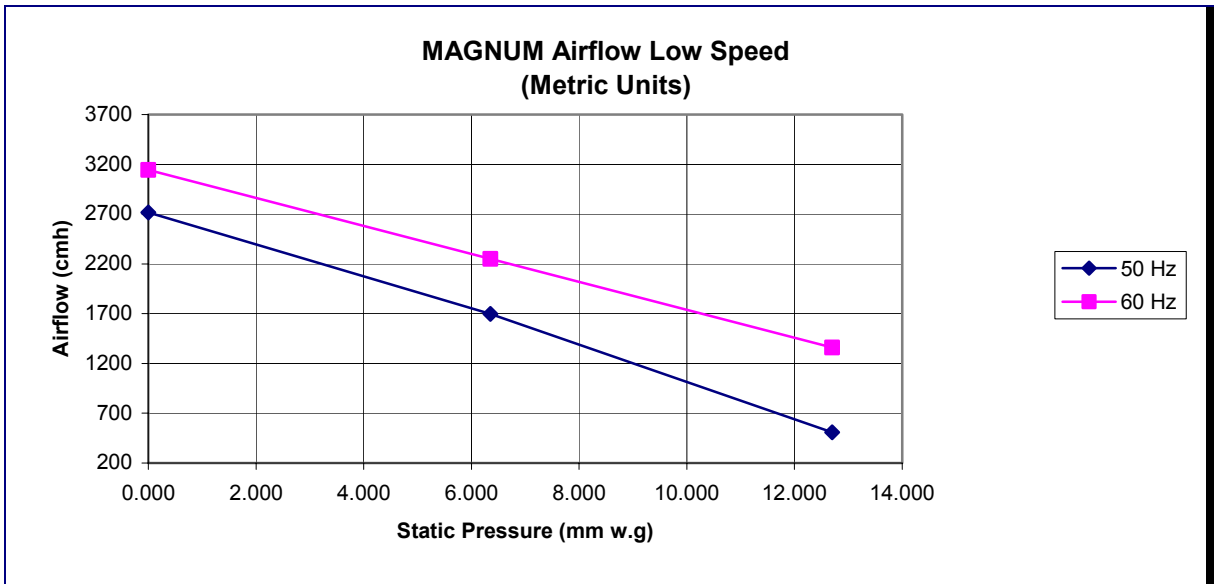
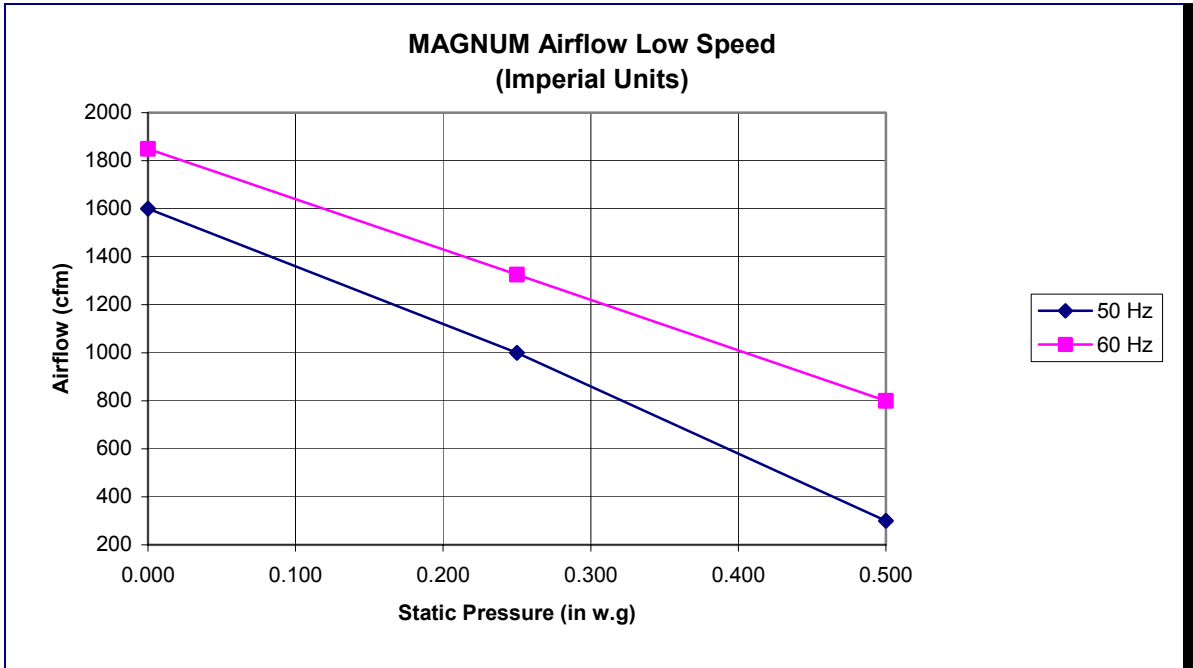

CREATED BY	W. BENSON	REVISION	G
BASE UNIT	MAGNUM		
REV. DATE	Mar 2 nd , 2005	PAGE 17 of	22

PIPING DIAGRAM

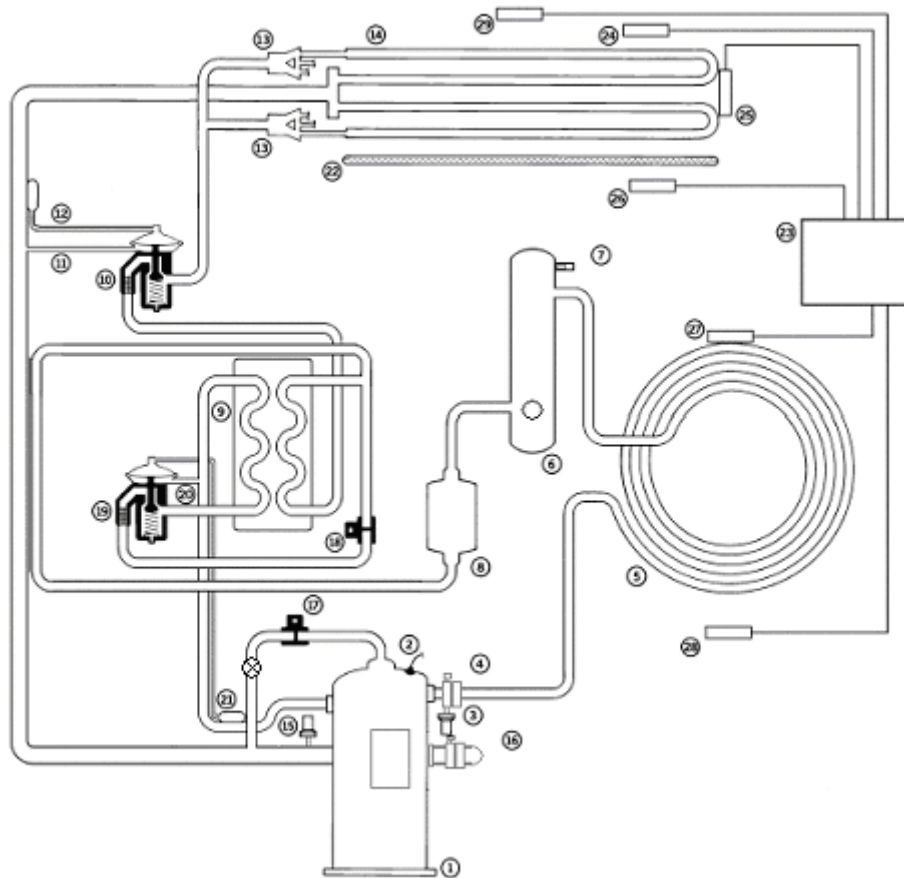

- | | |
|---------------------------------|--|
| 1. Scroll Compressor | 16. Suction Service Port |
| 2. Discharge Temperature Sensor | 17. Digital Control Valve with Service Valve |
| 3. High Pressure Cut-Out HPCO | 18. Economizer Valve |
| 4. Discharge Service Port | 19. Economizer TXV |
| 5. Condenser Coil | 20. Economizer TXV Equalizer Line |
| 6. Receiver Tank | 21. Economizer TXV Feeler Bulb |
| 7. Fusible Plug | 22. Electric Heaters |
| 8. Filter Drier | 23. MP3000 Microprocessor |
| 9. Economizer Heat Exchanger | 24. Return Air Sensor |
| 10. Expansion Valve | 25. Evaporator Coil Sensor |
| 11. TXV Equalizer Line | 26. Supply Air Sensor |
| 12. TXV Feeler Bulb | 27. Condenser Coil Sensor |
| 13. Evaporator Distributors | 28. Ambient Air Sensor |
| 14. Evaporator Coil | 29. Humidity Sensor |
| 15. Low Pressure Cut-Out LPCO | |

THERMO KING CORPORATION

CREATED BY	W. BENSON	REVISION	G
BASE UNIT	MAGNUM		
REV. DATE	Mar 2 nd , 2005	PAGE 18 of 22	

INSTALLATION DIAGRAMS

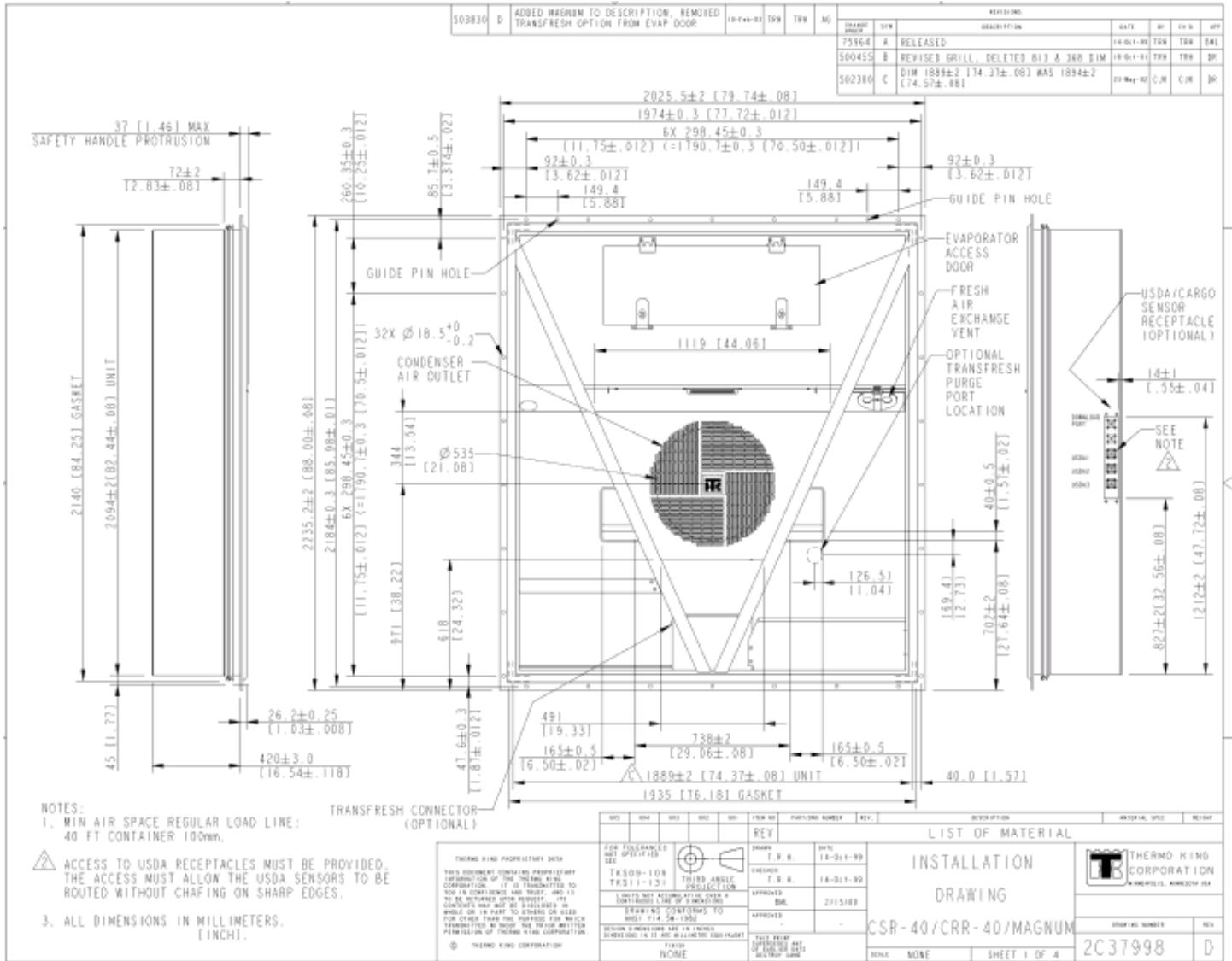

THERMO KING CORPORATION

CREATED BY	W. BENSON	REVISION	G
BASE UNIT	MAGNUM		
REV. DATE	Mar 2 nd , 2005	PAGE 19 of 22	

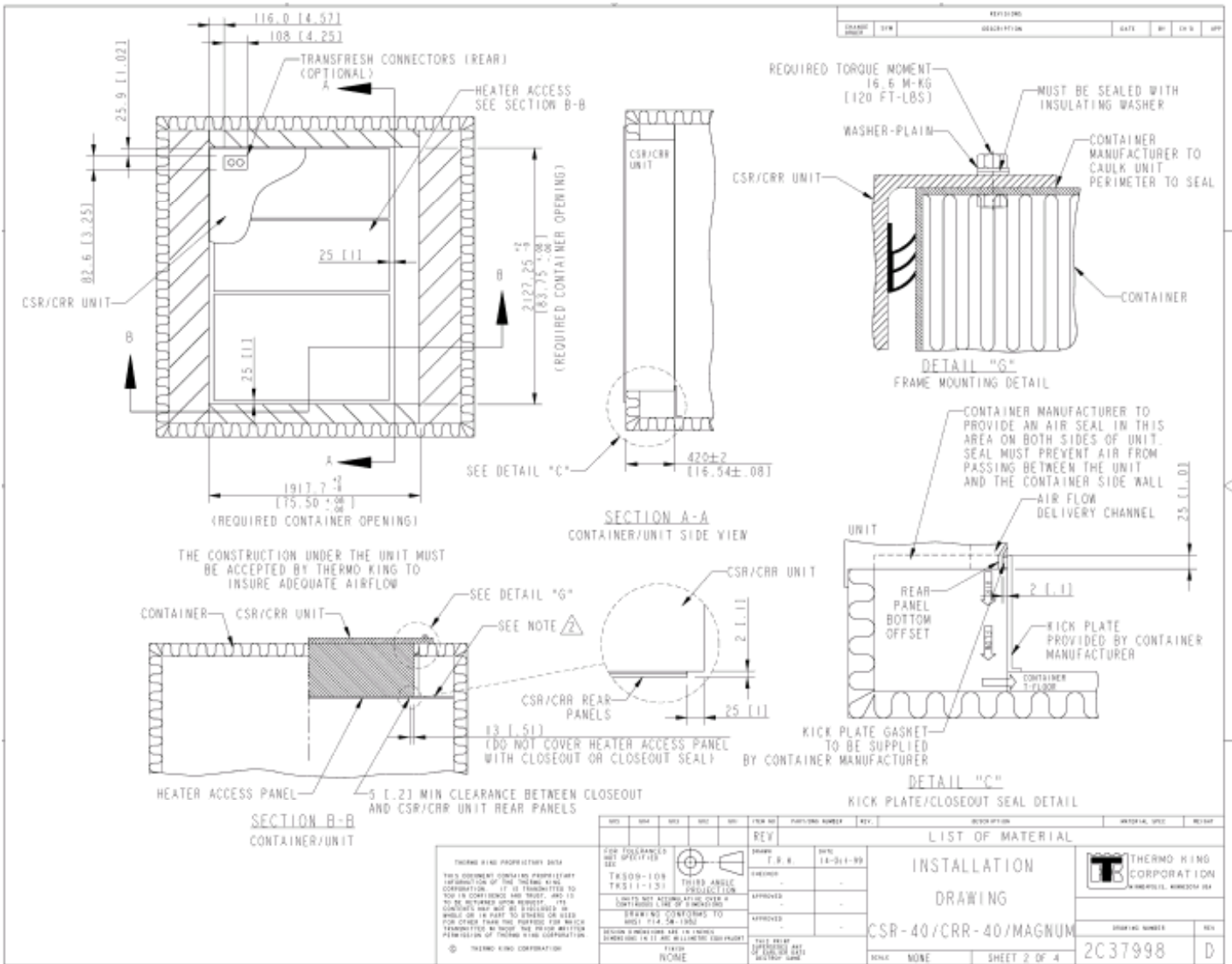

THERMO KING CORPORATION

CREATED BY	W. BENSON	REVISION	G
BASE UNIT	MAGNUM		
REV. DATE	Mar 2 nd , 2005	PAGE 20 of	22

CHANGED BY	DATE	DESCRIPTION	DATE	BY	CHK'D	APP'D

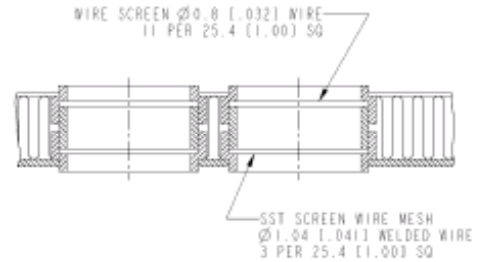
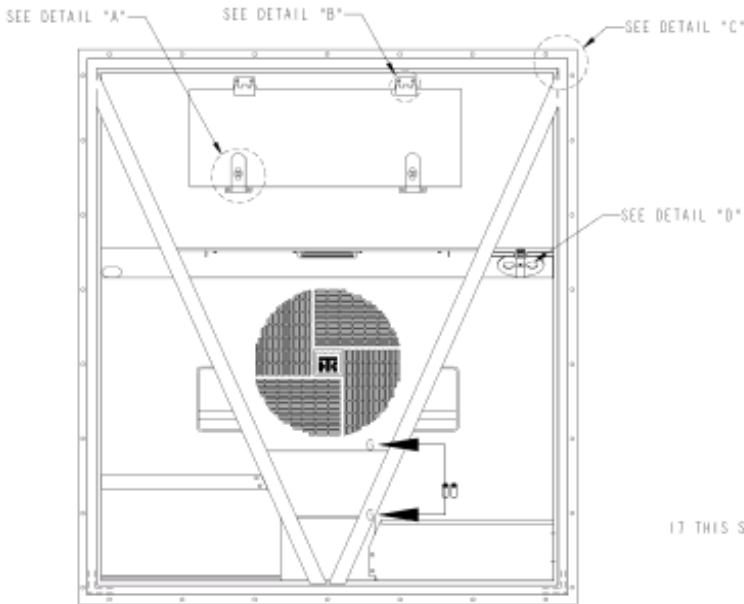

DETAIL "D"
FRESH AIR EXCHANGE DETAIL

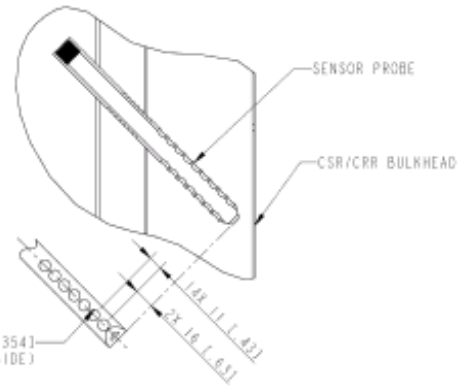

SECTION G-G
SUPPLY AIR SENSOR PROBE DETAIL

THERMO KING PROPRIETARY DATA

THIS DOCUMENT CONTAINS PROPRIETARY INFORMATION OF THERMO KING CORPORATION. IT IS FURNISHED TO YOU IN CONFIDENCE AND TRUST, AND IS TO BE KEPT STRICTLY CONFIDENTIAL. NO CONTENTS MAY BE DISCLOSED OR MADE OR IN PART TO BE MADE OR USED FOR OTHER THAN THE PURPOSE FOR WHICH FURNISHED, WITHOUT THE WRITTEN PERMISSION OF THERMO KING CORPORATION.

© THERMO KING CORPORATION

REV	DESCRIPTION	DATE	BY	CHK'D	APP'D
1	ISSUED	11-21-99	T.B.W.		
2	CHANGED				
3	APPROVED				
4	APPROVED				

QTY	DESCRIPTION	UNIT	REMARKS
1	WIRE SCREEN		
1	SST SCREEN WIRE MESH		
1	SENSOR PROBE		
1	CSR/CRR BULKHEAD		

FOR TOLERANCES NOT SPECIFIED SEE TR809-109 TRS11-131	FOR TOLERANCES NOT SPECIFIED SEE TR809-109 TRS11-131
UNITS NOT ALIGNED OVER 90° DIMENSIONS LINE OF DIMENSIONING	UNITS NOT ALIGNED OVER 90° DIMENSIONS LINE OF DIMENSIONING
DRAWING CONFORMS TO ANSI Y14.5M-1992	DRAWING CONFORMS TO ANSI Y14.5M-1992
SECTION DIMENSIONS ARE THE DIMENSIONS UNLESS OTHERWISE SPECIFIED	SECTION DIMENSIONS ARE THE DIMENSIONS UNLESS OTHERWISE SPECIFIED
FOR TOLERANCES NOT SPECIFIED SEE TR809-109 TRS11-131	FOR TOLERANCES NOT SPECIFIED SEE TR809-109 TRS11-131

LIST OF MATERIAL	
INSTALLATION DRAWING	
CSR-40/CRR-40/MAGNUM	
SCALE: NONE	SHEET 3 OF 4
DRAWING NUMBER: 2C37998	REV: D

THERMO KING CORPORATION

CREATED BY	W. BENSON	REVISION	G
BASE UNIT	MAGNUM		
REV. DATE	Mar 2 nd , 2005	PAGE 21 of	22

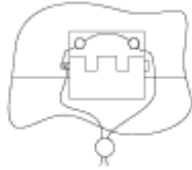

DETAIL "B"
EVAPORATOR SECTION
ACCESS DOOR HINGE
TIR SEAL DETAIL
TYPICAL 2 PLACES

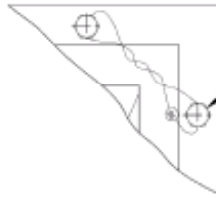

DETAIL "C"
FRAME TIR SEAL DETAIL

CONTAINER
MANUFACTURER
TO PROVIDE TIR
SEAL BOLTS

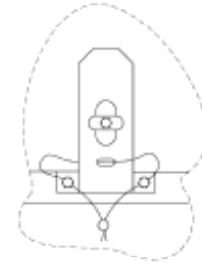

DETAIL "A"
EVAPORATOR ACCESS DOOR LATCH
TIR SEAL DETAIL
TYPICAL 2 PLACES

CHANGED BY	DATE	DESCRIPTION	DATE	BY	CHK'D	APP'D

REV	DATE	DESCRIPTION	MATERIAL	QTY
1	11-21-99	LIST OF MATERIAL		
2		INSTALLATION		
3		DRAWING		
4		CSR-40/CRR-40/MAGNUM		

THIS DOCUMENT CONTAINS PROPRIETARY INFORMATION OF THERMO KING CORPORATION. IT IS LOANED TO YOU IN CONFIDENCE AND MUST NOT BE REPRODUCED, COPIED, EITHER WHOLE OR IN PART TO OTHERS OR USED FOR OTHER THAN THE PURPOSE FOR WHICH IT WAS LOANED WITHOUT THE WRITTEN PERMISSION OF THERMO KING CORPORATION.

© THERMO KING CORPORATION

FOR TOLERANCES NOT SPECIFIED SEE TKS09-109 TRS11-131 TIR SEAL DETAIL

UNITS NOT ALIGNED OVER A CONTIGUOUS LINE OF DIMENSIONS

DRAWING CONFORMS TO ANSI Y14.5M-1994

SECTION DIMENSIONS ARE THE THERMO DIMENSIONS IN IT ARE ILLUSTRATED FOR REFERENCE

TIR SEAL TYPE: NONE

THIRD ANGLE PROJECTION

APPROVED

DATE: 11-21-99

SCALE: NONE

LIST OF MATERIAL

INSTALLATION

DRAWING

CSR-40/CRR-40/MAGNUM

SCALE: NONE

SHEET 4 OF 4

THERMO KING CORPORATION

MINNETONKA, MINNESOTA USA

DRAWING NUMBER: 2C37998

REV: D

THERMO KING CORPORATION

CREATED BY	W. BENSON	REVISION	G
BASE UNIT	MAGNUM		
REV. DATE	Mar 2 nd , 2005	PAGE 22 of	22

REVISIONS

a	May 10, 2002	Preliminary Release
A	Sept 10, 2002	Production Release
B	Oct 04, 2002	Updated Defrost Section and Minor Corrections
C	Oct 22, 2002	Updated Refrigerant Charge and pg. 12 setpoint range
D	Nov 22, 2002	Corrected coil surface areas
E	Jan 28, 2003	Added Digital service valve. Updated control valve chart
F	Feb 20, 2003	Updated installation drawings and evap fan material. Updated location of compressor temperature sensor.
G	Mar 02, 2005	Changed USDA from Cannon PT100 to Deutsch NTC